

Find and Write the 'It' Words

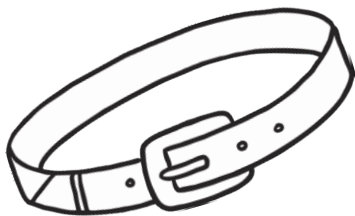

Write the words and then colour the ones with a 'It' sound in them.



	e		
--	---	--	--



		d	
--	--	---	--



m			
---	--	--	--

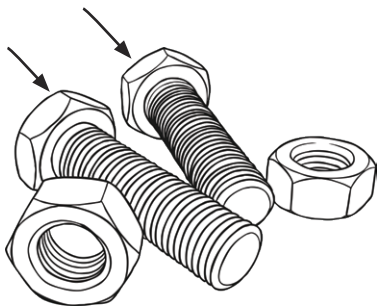

b			
---	--	--	--

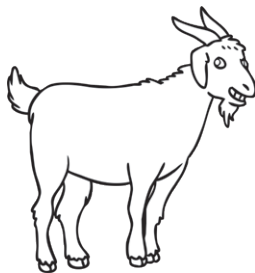

		t	
--	--	---	--

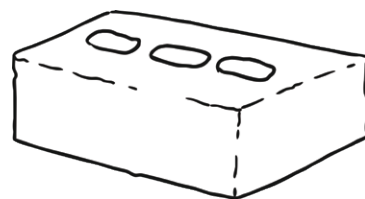

	r		
--	---	--	--

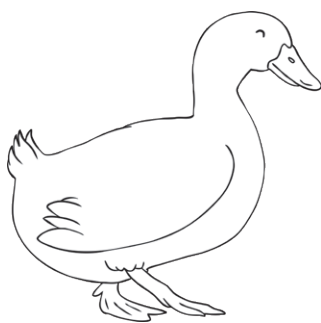

	u		
--	---	--	--

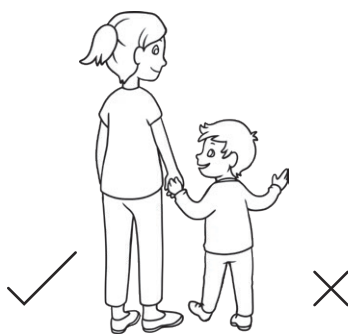

	d		
--	---	--	--

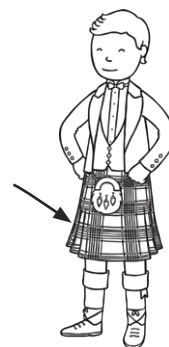





k			
---	--	--	--

Find and Write the 'It' Words

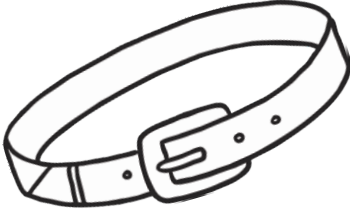

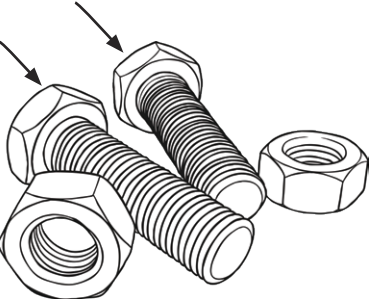
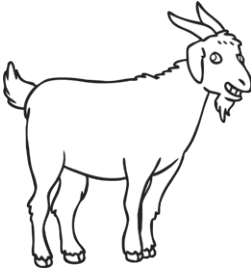
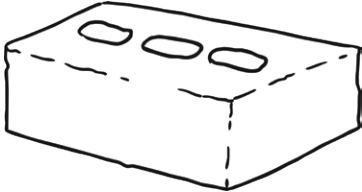
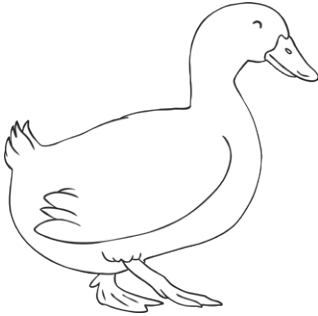
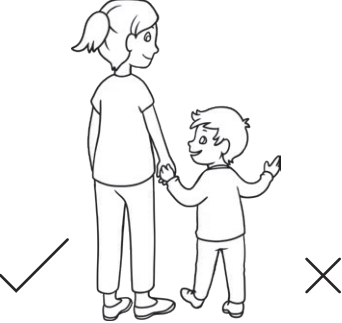



Write the words and then colour the ones with a 'It' sound in them.

 <input type="text"/> <input type="text"/> <input type="text"/> <input type="text"/>	 <input type="text"/> <input type="text"/> <input type="text"/> <input type="text"/>	 <input type="text"/> <input type="text"/> <input type="text"/> <input type="text"/>
 <input type="text"/> <input type="text"/> <input type="text"/> <input type="text"/>	 <input type="text"/> <input type="text"/> <input type="text"/> <input type="text"/>	 <input type="text"/> <input type="text"/> <input type="text"/> <input type="text"/>
 <input type="text"/> <input type="text"/> <input type="text"/> <input type="text"/>	 <input type="text"/> <input type="text"/> <input type="text"/> <input type="text"/> <input type="text"/>	 <input type="text"/> <input type="text"/> <input type="text"/> <input type="text"/>

Find and Write the 'It' Words

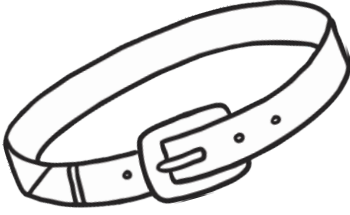

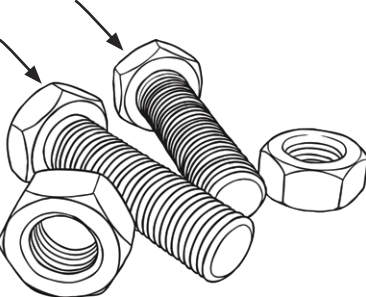
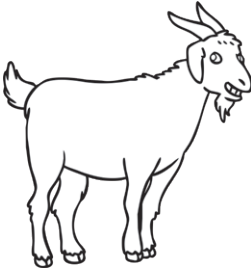
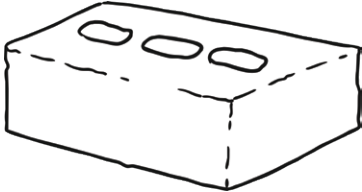
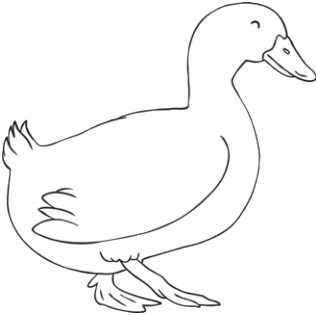
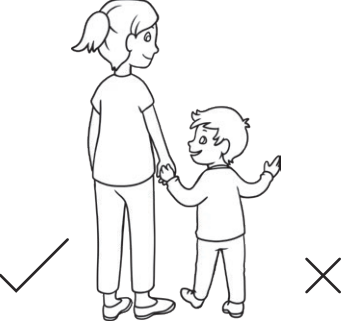
Write the words and then colour the ones with a 'It' sound in them.

 _____	 _____	 _____
 _____	 _____	 _____
 _____	 _____	 _____

Find and Write the 'lt' Words



Write the words and then colour the ones with a 'lt' sound in them.

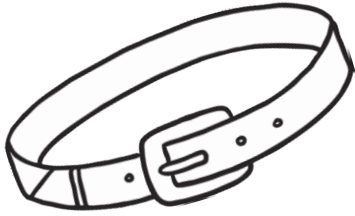

b	e	l	t
---	---	---	---

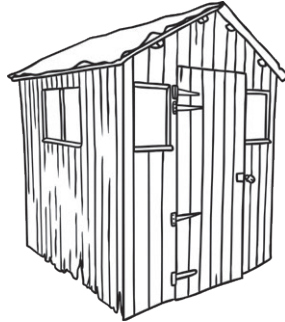

sh	e	d
----	---	---



m	e	l	t
---	---	---	---

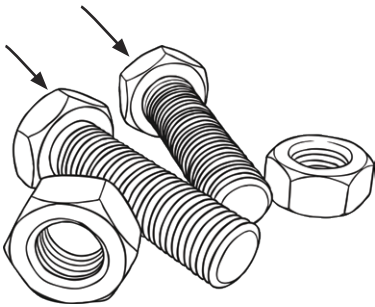

b	o	l	t
---	---	---	---

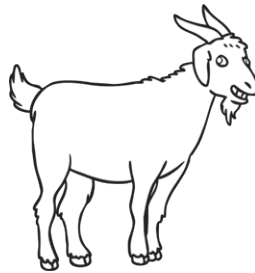

g	o	a	t
---	---	---	---

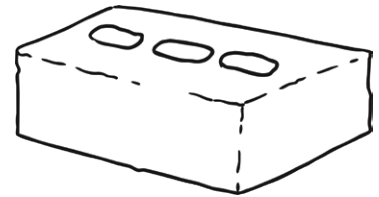

b	r	i	ck
---	---	---	----

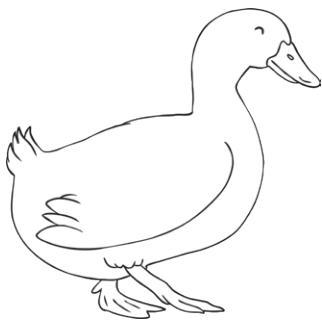

d	u	ck
---	---	----

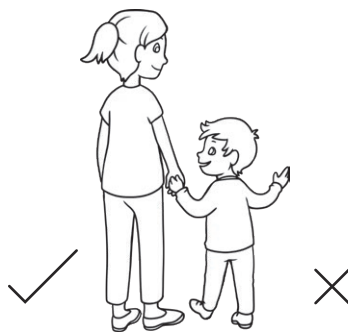

a	d	u	l	t
---	---	---	---	---

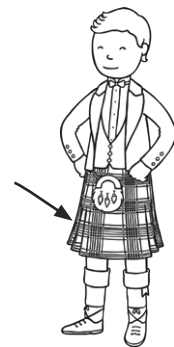

k	i	l	t
---	---	---	---